

INSTALLATION DETAIL

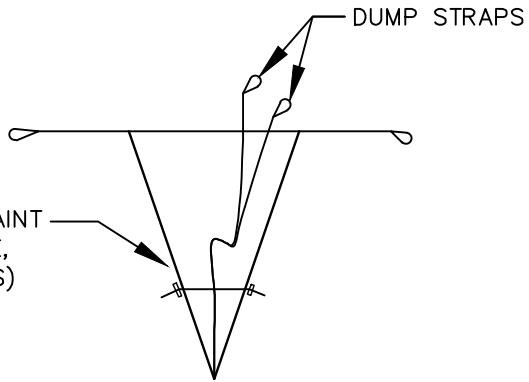

BAG DETAIL

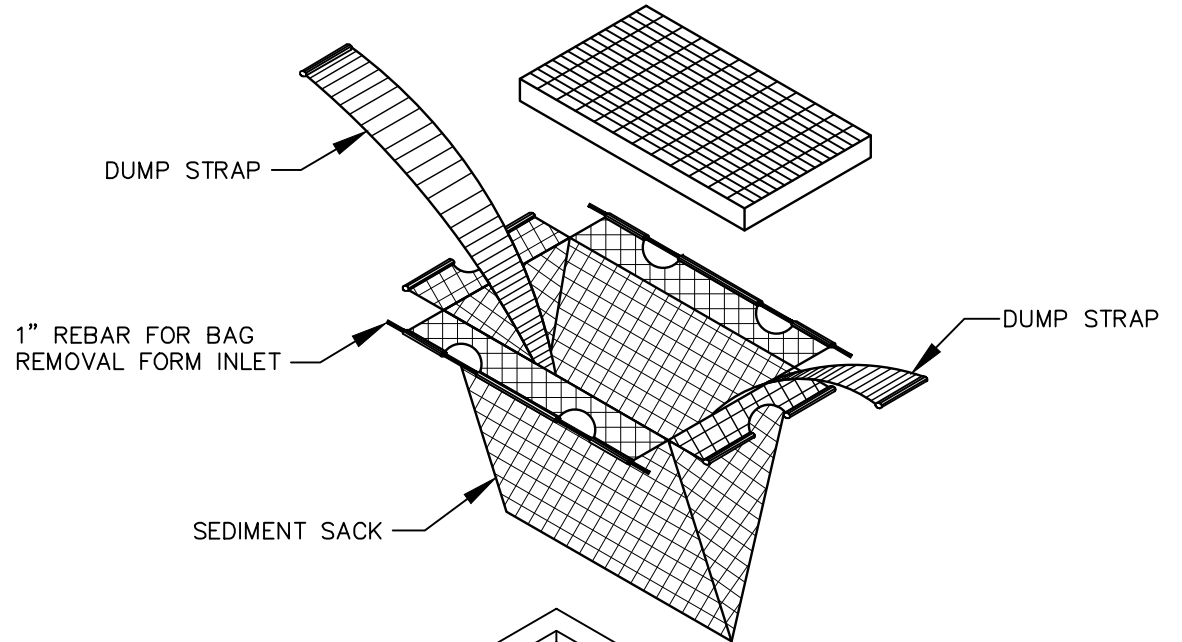
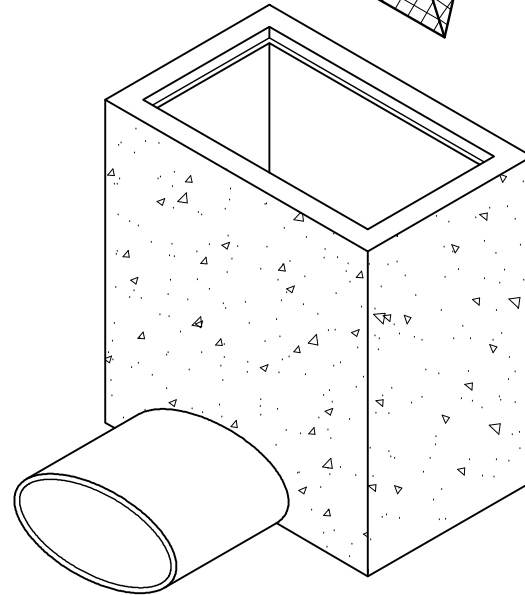

EFFECTIVE: 12/10/09

STANDARD INLET SEDIMENT CONTROL DEVICE

DETAIL No.

04000.19

SHEET 1 OF 1