

BOTTOM SECTION

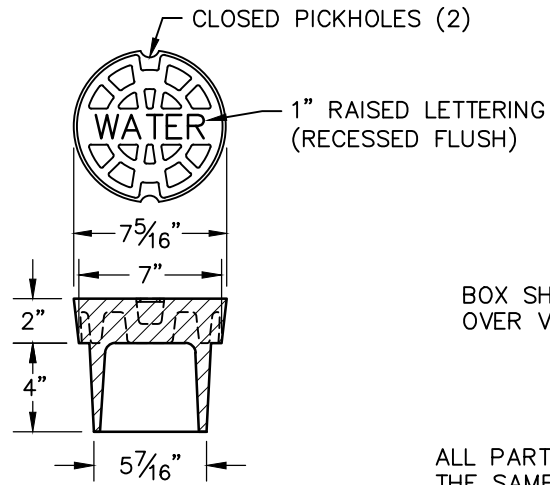

LID

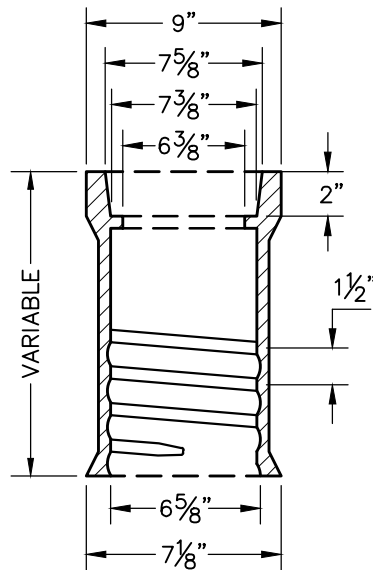

TOP SECTION

BOX SHALL BE CENTERED
OVER VALVE

ALL PARTS SHALL BE OF
THE SAME MATERIAL AND
SUPPLIED BY THE SAME
MANUFACTURER

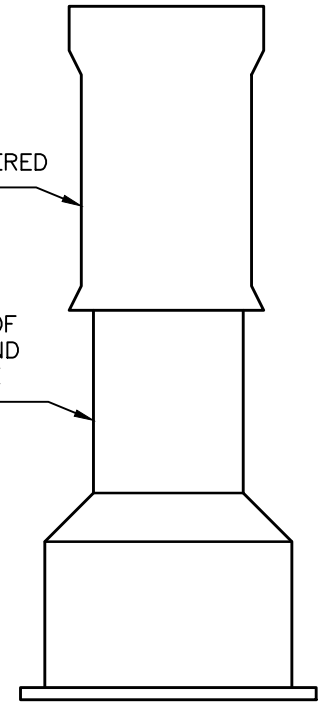

COMPLETE BOX

NOTES:

1. VALVE BOX COVER SHALL WEIGH A MINIMUM 24 lbs.
2. ENTIRE VALVE BOX ASSEMBLY & COVER SHALL BE CAST FROM CLASS 35 GRAY IRON.
3. ASSEMBLY SHALL BE DOMESTICALLY MADE AND MANUFACTURED IN THE U.S.A.



EFFECTIVE: 01/05/17

STANDARD WATER VALVE BOX

DETAIL No.

06000.08

SHEET 2 OF 3