

A 1½" DEEP CUT SHALL BE MADE PERPENDICULAR TO BACK OF CURB AND THEN PARALLEL WITH GUTTER LINE

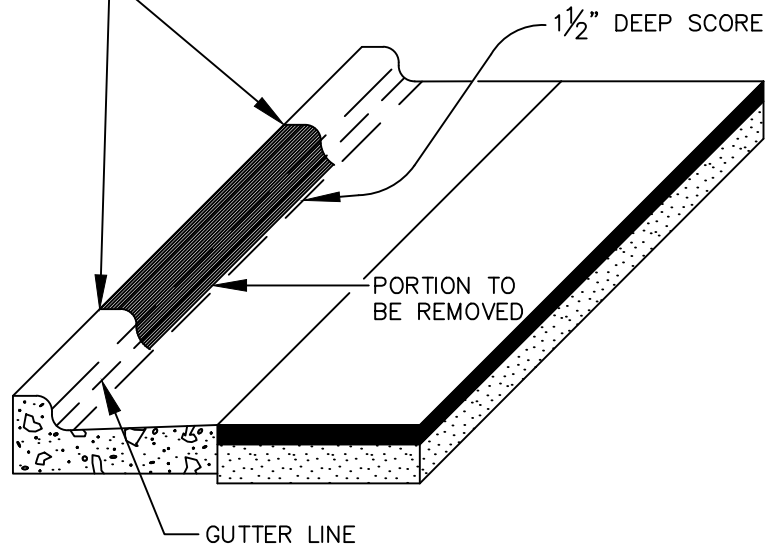

STEP ONE

PORTION TO BE REMOVED AND REPLACED WITHIN THREE (3) WORKING DAYS

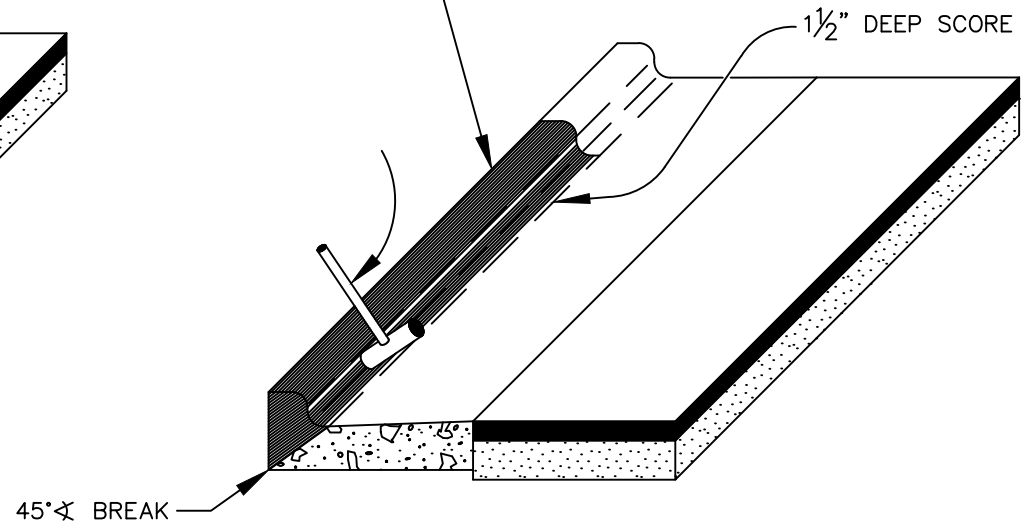

STEP TWO

NOTES:

1. CURB AND GUTTER SECTION SHALL BE REMOVED IN ACCORDANCE WITH DRIVEWAY WIDTH APPROVED BY THE TOWN.
2. IF PERPENDICULAR CUT IS WITHIN 12 INCHES FROM A JOINT, THEN THE PARALLEL CUT SHALL BE MADE TO THAT JOINT.
3. THIS METHOD IS NOT ALLOWED IN NEW SUBDIVISION CONSTRUCTION.



EFFECTIVE: 01/05/17

**STANDARD METHOD OF REMOVING EXISTING CURB
(FOR A DRIVEWAY APRON INSTALLATION)**

DETAIL No.

03000.10
SHEET 1 OF 1